

Making an Insect

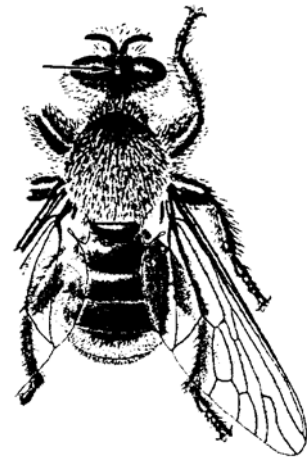

Collection

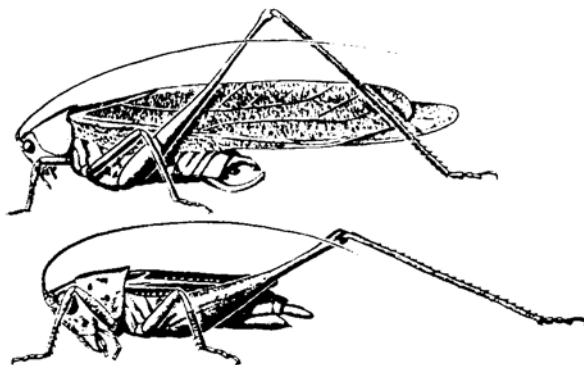

CONTENTS

	Page
Equipment for Collecting Insects	3
How to Make Your Net	3
How to Make Your Killing Jar	4
Making a Pinning Block	4
Making a Spreading Board	4
Boxes	4
Where to Collect Insects	5
How to Mount and Preserve Your Collection	5
How to Relax Dry Insects	6
How to Label Insects	6
Arranging in Box	6
Identifying the Insects	6
What Makes a Good Collection	7
Suggestions for Making a Good Collection	7
Protection of Collection From Insects	7

Recommended for Arkansas 4-H by the University of Arkansas Division of Agriculture Extension entomologists. **DR. JOHN D. HOPKINS** is associate professor and Extension entomologist, Little Rock, **DR. GLENN STUDEBAKER** is associate professor and Extension entomologist, Northeast Research and Extension Center, Keiser, **DR. GUS M. LORENZ, III**, is professor, Extension entomologist and IPM coordinator, Lonoke, and **DR. KELLY M. LOFTIN** is associate professor and Extension entomologist, Fayetteville. All are with the University of Arkansas Division of Agriculture, Cooperative Extension Service.

Gordon Barnes, Dr. Bill F. Jones and Dr. Donald R. Johnson, retired Extension entomologists, are authors of previous editions of this publication.

MAKING AN INSECT COLLECTION

By **Dr. John D. Hopkins, Assistant Professor and Extension Entomologist,**
Dr. Glenn Studebaker, Assistant Professor and Extension Entomologist,
Dr. Gus M. Lorenz, III, Professor, Extension Entomologist and IPM Coordinator,
Dr. Kelly M. Loftin, Assistant Professor and Extension Entomologist, and
Dr. Scott Akin, Assistant Professor and Extension Entomologist

Insects are small invertebrate (lacking a backbone) animals. They have all the body processes of the higher animals (vertebrates) and are very interesting to study. Insects are classified according to the following series of categories. An example of the classification of the housefly is given below.

Kingdom	Animal
Class	Insecta
Order	Diptera
Family	Muscidae
Genus	<i>Musca</i>
Species	<i>domestica</i>
Describer	Linnaeus
Common name	house fly

In some widely varying orders, there may be a classification of suborder. Some families may have a classification category of superfamily and subfamily.

Insects make up the majority of the animal kingdom. In Arkansas alone there are probably 20,000 different kinds of insects. It is important for anyone who wants to learn about the world around him to spend a considerable part of his time learning about insects. The best way to begin is by making a collection.

Many insects are so distinctive that they are easily recognized at a distance. There are many others, however, which cannot be distinguished from their near relatives unless specimens of both are available together for comparison. This is the great value of a collection. You will find many of the insects which you lump together as "May beetles," "houseflies" or "grasshoppers" are actually a mixture of many species, each with a particular way of life. You will also find that every tiny flying insect is not a "gnat." You will be amazed at the variety of insects you can find on your own farm, in your town or even in your own back yard.

Equipment for Collecting Insects

A small amount of inexpensive equipment is necessary for collecting and mounting insects.

The following things should be obtained by the beginner:

1. Insect net
2. Killing jar
3. Insect pins
4. Pinning block
5. Spreading board
6. Storage boxes and display boxes

How to Make Your Net

To help in collecting insects, a sweep net is useful. It is especially useful in sweeping for small insects. Sweep nets may be purchased or made at home. A plan for making a sweep net is as follows:

Equipment:

1. Small wooden handle, about 3 feet long (broom handle).
2. Smooth stiff wire 5 feet long (telephone wire).
3. A piece of cloth 3 x 5 feet (muslin or mosquito netting).
4. Piece of fine wire to wrap wire hoop ends to handle.

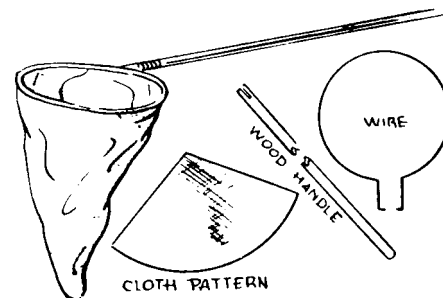

Insect Collecting Net

On one end of the handle, cut two grooves lengthwise on opposite sides the depth and the thickness of the wire. Make one groove 2 1/2 inches long and the other 3 1/2 inches long. Drill a small hole into the handle at the end of each groove. Bend the wire to form a hoop. Cut the cloth a triangular shape with the top circled. Hem the top and sew the sides together. Attach to the wire circle. Wire the hoop to the handle.

How to Make Your Own Killing Jar

Any jar or large-mouthed bottle with a tight lid makes a good killing bottle. Chips of rubber, sponge, celotex, cotton or similar absorbent material should be placed in the bottom of the jar. A piece of corrugated cardboard should be cut the size of the bottom of the jar and placed over the chips to keep them in place. The bottle should be charged as needed with killing agent. Many of the volatile chemicals are effective.

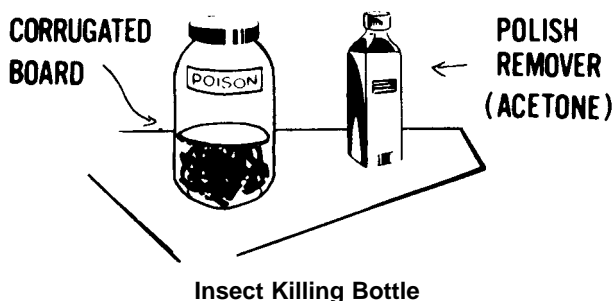

Making a Pinning Block

A pinning block is used to get the insect and labels at the same height on each pin. A pinning block may be made from a single piece of wood 1 inch square and 4 inches long or by gluing several 1/4-inch by 1-inch pieces together to form 1-inch square steps, 1/4 inch, 1/2 inch, 3/4 inch and 1 inch thick. Small holes just large enough for the head of the insect pin to slip through are bored through the center of each step.

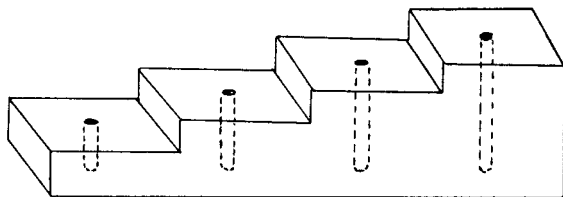

Making a Spreading Board

To spread the wings of moths and butterflies until they dry, a spreading board is needed. Several sizes of spreading boards are used by the professional. For most insects, a good spreading board can be made. The bill of materials for a spreading board is:

- Two pieces 5 1/2 inches long and 1 inch square for the ends.

- Two pieces 1/2 inch x 2 1/2 inches x 16 inches for the top pieces. These should be planed so that one side of each is sloped down to 3/8 inch thick.
- One strip of balsa wood, styrofoam, cork or other soft material 1/2 inch x 1 inch x 14 inches for the pinning strip in the bottom of the slot.
- A pinning board may be made from styrofoam by cutting a slot. The moth body is placed in the slots and wings spread.

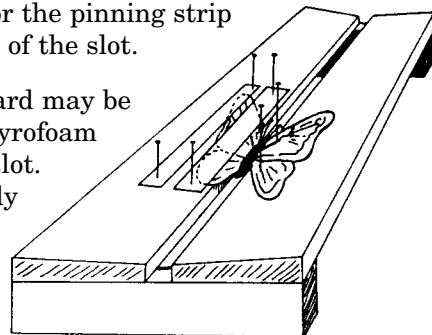

Boxes

Cigar boxes or similar type boxes with corrugated board placed in the bottoms make good collecting and storage boxes. Exhibit or display boxes can be purchased or made. Arkansas collections should be exhibited or displayed in a box 18 inches x 24 inches x 2 5/8 inches with a plexiglas top.

Bill of Materials

- 1 piece masonite 18" x 24"
- 2 side pieces 1" x 2 5/8" x 24" – grooved
- 1 end piece 1" x 2 5/8" x 16 1/2" – grooved
- 1 end piece 1" x 2 1/4" x 16 1/2"
- 1 end piece 1" x 3/8" x 16 1/2" – grooved
- 1 piece styrofoam or celotex, 1/2" x 16 1/2" x 22 5/8"
- 10 screws
- 10 flat head box nails
- 1 piece plexiglas 17" x 23 1/2"

The two side pieces and one end piece are grooved 1/8" wide and 1/4" deep 1/4" down from inside the top. The end piece 1" x 3/8" x 16 1/2" has a groove on one side 1/8" x 1/4" to fit over plexiglas to hold it in place.

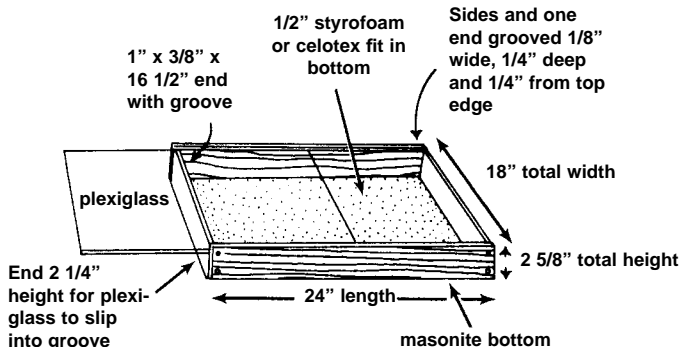

Where to Collect Insects

Insects may be collected at any time during the year. There is at least one species or kind of insect that feeds or lives on every kind of plant, mammal and bird. Some plants support many different kinds of insects. The more places insects are collected, the larger and more varied the collection is likely to be. The following insect habitats can be used as a guide to making a collection:

1. **Pastures:** grasshoppers, butterflies, tree crickets, walkingsticks, leafhoppers, beetles, crane flies, wasps.
2. **Cultivated plants:** butterflies, beetles, squash bugs, stink bugs and many other injurious insects.
3. **Woodlands:**
 - A. Foliage of trees and shrubs: beetles, wasps, praying mantis, walkingstick.
 - B. Decayed logs and stumps: beetles, termites, ants.
 - C. Loose bark of logs and stumps: beetles, wasps, cockroaches, springtails.
 - D. Sap of freshly cut trees: moths, wasps, beetles.
 - E. Under damp leaves: springtails, beetles, leafhoppers, beetles.
 - F. Flowers: butterflies, bumble bees, wasps, beetles.
4. **Buildings:**
 - A. Newspapers: bristletails, booklice.
 - B. Flooring: termites, powderpost beetles.
 - C. Basement: cockroaches.
 - D. Clothes closets: bristletails, clothes moths.
5. **Domestic and wild mammals and birds:** biting lice, sucking lice, fleas, horse flies, horn flies, bot flies.
6. **Farm lot:**
 - A. Manure: beetles, flies.
 - B. Stored grain: moths, caterpillars, beetles, booklice.
 - C. Shocks of grain: crickets, beetles.
 - D. Straw piles: earwigs, crickets, beetles.
7. **Water:**
 - A. Ponds, lakes, streams: water striders, whirligig beetles, water scorpions, giant water bugs, springtails, water boatmen, back swimmers, dobsonflies, stoneflies, mayflies, dragonflies, beetles.
 - B. Mud, sandbars, gravel or clay banks: toad bugs, pygmy grasshoppers, mole crickets, tiger beetles.
 - C. Weeds and leafy branches near water: damselflies, dragonflies, beetles,

leafhoppers, flies, stoneflies, mayflies, caddisflies.

8. **Weeds and flowers along roadside:** grasshoppers, stink bugs, beetles, scorpion flies, treehoppers, tree crickets, wasps, bees, butterflies, blister beetles.
9. **Special places:**
 - A. Boards and stones: ants, termites, beetles, crickets, springtails.
 - B. Lights at night: moths, beetles, lacewings, praying mantis, katydids, jarflies, dobsonflies, assassin bugs, giant water bugs, caddisflies, mayflies, stoneflies.
 - C. Greenhouses: plant lice, thrips, earwigs.
 - D. Dead or decaying bodies of animals: rove beetles and other scavengers.

How to Mount and Preserve Your Collection

A display collection should contain only adult insects. All insects must be pinned or glued to small card triangles.

Insects should be mounted on regular insect pins, not common pins. Any insect too small to pin through the body should be glued to a card point made by cutting a triangle 3/8-inch and 1/8-inch wide at the base from a file card or similar material. The pin should be inserted at the base of the triangle.

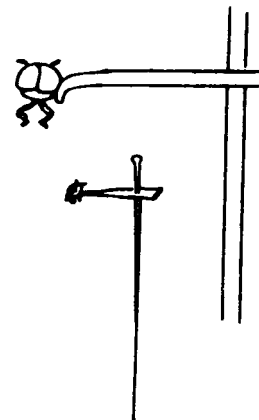

All insects should be pinned so that the upper surface on the insect is 1/2-inch below the head of the pin. This is done by inserting the pin head first through the 1/2-inch section of the pinning block after the insect has been pinned.

Insects that are large enough should be pinned directly through the body, usually just off

center to the right. Different kinds of insects have different locations on the body where pins should be inserted. The following rules should be followed:



1. Bees, wasps, flies, etc. – Pin through the thorax between the bases of the fore wings and just to the right of the middle line.

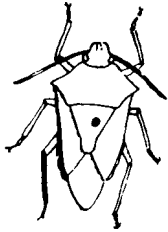

2. Stink bugs – Pin through the scutellum, which is the triangular area between the bases of the wings.



3. Grasshoppers, crickets, etc. – Pin through the prothorax or "saddle" just to the right of the center line.



4. Beetles – Pin through the fore part of the right wing cover near the center line.

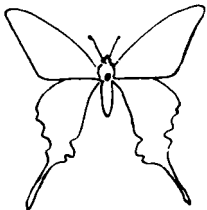

5. Butterflies, moths, dragonflies, etc. – Pin through the center of the thorax between the bases of the fore wings.

The wings of moths and butterflies should be spread on a spreading board.

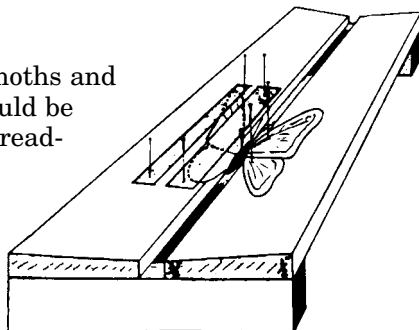

How to Relax Dry Insects

All insects should be pinned while fresh if at all possible. At times specimens may dry out before they can be pinned. Dry specimens may be relaxed by putting them into a relaxing chamber for one or two days. A relaxing chamber can be made from a large jar with a wide mouth and a tight-fitting lid. Place 2 inches of clean sand in the bottom of the jar and saturate it with water to which two to three drops of carbolic acid have been added to control mold. Place insects in an open container on top of the wet sand and put the lid on the chamber airtight. Pin insects just as soon as they are soft. Specimens left too long in the relaxing chamber will be ruined.

How to Label Insects

Insects should all be labeled with two labels 1/2 inch wide and 3/4 inch long made from file cards. The location, date and the name of the collector should be printed on the top label and the common name, where possible, should be printed on the lower label.

Labels should be placed at uniform heights. Use the different sections of the pinning block to obtain the proper height. Labels should be placed parallel to the length of large insects, so that they are read from the left side with insect facing away. Labels on point-mounted insects should be parallel with points and read from the bottom.

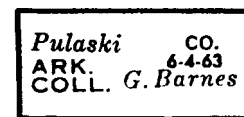

Arranging in the Box

A piece of blank paper should be fitted in the bottom of the box. Insects are then arranged in columns in horizontal rows with not more than four specimens of each kind to a row. Each Order is separated by a label in the column at the top of the first row of insects in that particular Order. The Order name should be printed or typed on a piece of plain white paper 1/2 inch wide by 2 inches in length and pinned to the bottom of the box with two pins.

Identifying the Insects

Twenty-five of the 31 total insect Orders can easily be collected in Arkansas. At least one species of these Orders is commonly present in all

localities. Keys and reference material should be used to properly identify insects to Order.

What Makes a Good Collection

A useful collection consists of many different species of insects, neatly mounted, labeled and arranged in good display boxes. Uniformity of labeling, mounting and arranging is of utmost importance in making an attractive collection.

Insect collections will be judged according to the following score card:

1. Different Orders correctly identified. 25 points
2. Pinning and spreading technique. 25 points
 - a. Proper wing spreading. 5 points
 - b. Pins inserted properly. 5 points
 - c. Uniform height on pins. 5 points
 - d. Insects level and straight. 5 points
 - e. Condition of specimens. 5 points
3. Identification and labeling. 25 points
 - a. Labels neat and accurate. 5 points
 - b. Labels uniform height on pins. 5 points
 - c. Labels not twisted on pins. 5 points
 - d. Insects assigned correct Order. 5 points
 - e. Accuracy of common names. 5 points
4. General appearance of collection. 25 points
 - a. Variety of insects. 5 points
 - b. No species duplication. 5 points
 - c. Grouping and spacing. 5 points
 - d. Arrangement and background. 5 points
 - e. Educational features added. 5 points

Suggestions for Making a Good Collection

1. Use undamaged specimens.
2. Spread the wings of Lepidoptera.
3. Place all insects the same height on the pins.
4. Use only regular insect pins.
5. Use uniform labels placed the same height on pins and kept straight.
6. Group each Order in columns under the Order label and arrange the specimens in neat, straight rows.
7. Varnished and waxed display cases are more attractive.
8. Use white or light color background in the bottom of the box to show insect specimens to best advantage.

Protection of Collection From Insects

Insect collections are often destroyed by other insects which feed on dry insects. Collections may be protected by using moth balls placed in the box. The box should be kept tightly closed.

Order: Thysanura (Silverfish)

Wings – None

Mouthparts – Chewing

Metamorphosis – None

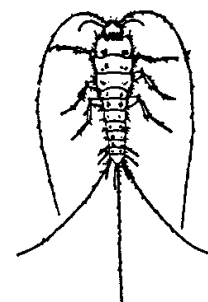

Added Note – Silver-colored insects with long antennae and two or three long antennae-like appendages at the end of the abdomen. The silverfish feed on rayons, starched clothes, bookbindings and other materials having starch or glue. Can be found in feed or flour mills where starchy foods are handled or in sinks and bathtubs of homes.

Order: Microcoryphia (Jumping Bristletails)

Wings – None

Mouthparts – Chewing

Metamorphosis – None

Added Note – Jumping bristletails are wingless insects similar to silverfish. They jump when disturbed and are usually found in grassy or wooded areas under leaves, bark or dead wood.

Order: Collembola (Springtails)

Wings – None

Mouthparts – Chewing

Metamorphosis – None

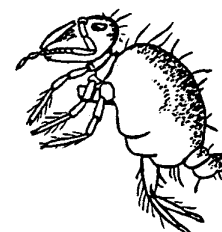

Added Note – Very small insects less than 1/5 inch long. Flip themselves into the air by means of a spring-like part under the abdomen. Found in damp places, such as under decaying vegetation, stones and boards.

Order: Ephemeroptera

(Mayflies)

Wings – Two pairs. First pair much larger than second pair. Held vertically when at rest.

Mouthparts – None

Metamorphosis – Incomplete

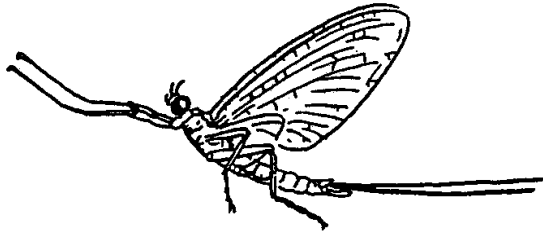

Added Note – Found near water and are attracted to lights. Have two or three long antennae-like appendages at the end of the abdomen.

Order: Odonata

(Dragonflies, Damselflies)

Wings – Two pair

Mouthparts – Chewing

Metamorphosis – Incomplete

Added Notes – Two pairs wings same thickness with 12 or more cross veins; both pairs wings same length. Tarsus (foot) with less than five segments.

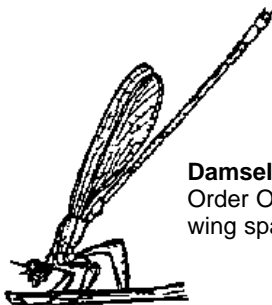

Damselfly
Order Odonata
wing span 2 inches

The different damselflies are known by the family names; found about ponds and streams; adult feeds on soft-bodied insects; nymph is fish food.



Dragonfly
Order Odonata
wing span 3 inches

Several different dragonflies exist in Arkansas. Some common names are gray darners, cordulegasters, club-tailed, common darners. Distinguished by large size and rapid flight; lives about fresh water, feeds on other insects.

Order: Orthoptera

(Grasshoppers, Crickets)

Wings – Two pairs (camel crickets are wingless)
Top pair – Leathery
Bottom pair – Membranous and folded under top pair

Mouthparts – Chewing

Metamorphosis – Gradual

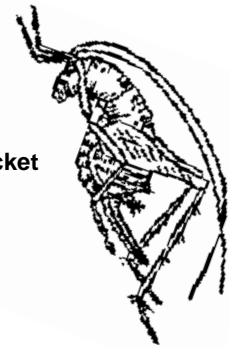

Camel Cricket

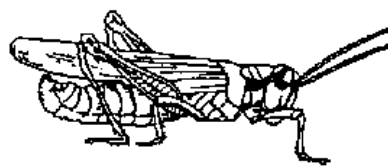

Red-legged Grasshopper



Field Cricket

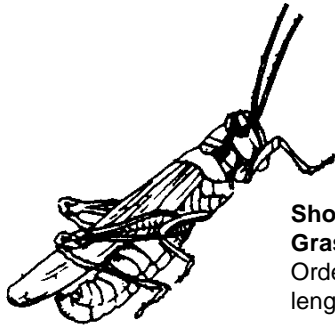

Short-horned Grasshopper
Order Orthoptera
length 2 1/4 inches

Commonly seen hopping or flying in grassy areas; voracious plant feeder, found world-wide. Several species (600 in North America) including differential, red-legged, lesser migratory, clearwinged and several others of lesser abundance.



Tree Cricket
Order Orthoptera
length 3/4 inch

Several species; delicate, slender, greenish; lives in weeds, trees, bushes; punctures twigs and branches to deposit eggs.

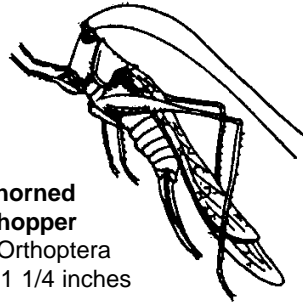

Long-horned Grasshopper
Order Orthoptera
length 1 1/4 inches

Adult female; pretty, light green, called "meadow grasshopper"; general feeder. Several species including cone-nosed and meadow grasshopper.

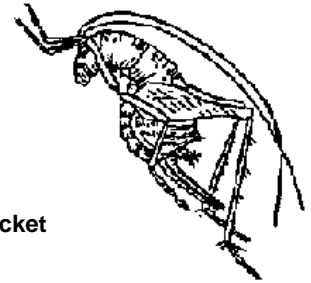

Stone or Camel Cricket
Order Orthoptera
length 4/5 inch

Wingless long-horned 'hopper; high-arched back like camel; eats plants in dark, moist places.

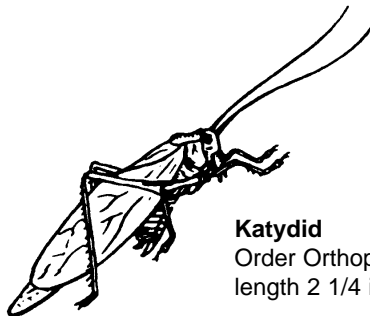

Katydid
Order Orthoptera
length 2 1/4 inches

Several species; general foliage feeder; summer singer of "Katy did, Katy didn't."

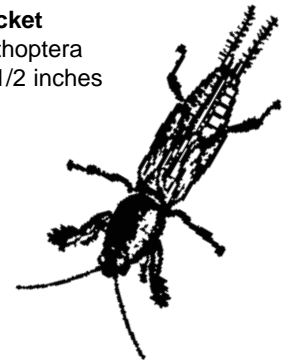

Mole Cricket
Order Orthoptera
length 1 1/2 inches

Several species. Covered with fine, brown, velvety hairs; burrows, nests in soil near water; feeds on plant roots.

Order: Mantodea

(Preying Mantids)

Wings – Two pair

Mouthparts – Chewing

Metamorphosis – Gradual

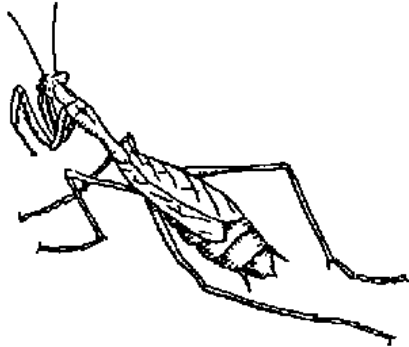

Added Note – Preying mantids have front legs with teeth-like structures for holding prey. The head is quite moveable and mantid can look over its shoulder. Preying mantids catch and feed upon other insects.

Order: Phasmida

(Walkingsticks)

Wings – None

Mouthparts – Chewing

Metamorphosis – Gradual

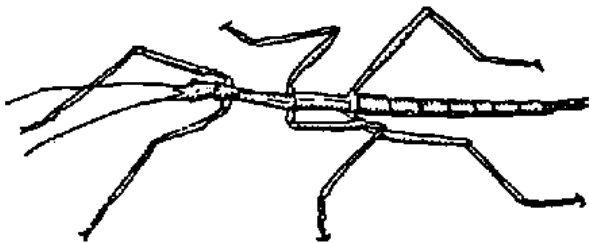

Added Note – The body is long and sticklike and the wings are usually absent or very reduced. The walkingsticks are slow moving, herbivorous insects that are usually found on trees or shrubs. They are very similar in appearance to a twig. walkingsticks are able to emit a foul-smelling substance.

Order: Blattaria

(Cockroaches)

Wings – Two pair

Mouthparts – Chewing

American or
German Cockroach

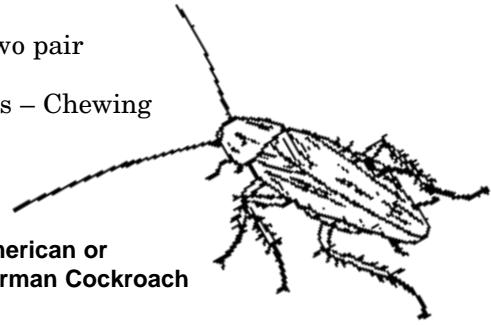

Metamorphosis – Gradual

Added Note – Cockroaches have flat bodies and tend to be oval shaped. They are fast runners and usually move about during the night.

Order: Isoptera

(Termites)

Wings – Two pairs of the same length (workers are wingless)

Mouthparts – Chewing

Metamorphosis – Gradual

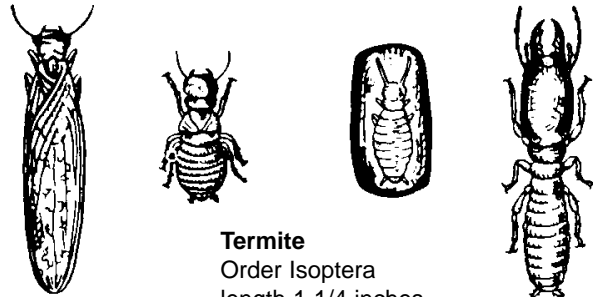

Added Note – Kings and queens may be collected while swarming, and workers may be found infesting wood. Look under wood on the ground.

Two pairs of wings same thickness and sturdiness; more than 12 cross veins with both pairs equal width and length and much longer than body; wings milky white in color.

Winged adult, second-generation caste, worker, soldier; live in social colonies; infest house timber.

Order: Dermaptera

(Earwigs)

Wings – Two pairs

Mouthparts – Chewing

Metamorphosis – Gradual

Added Note – Front pair of wings like those of beetles but very short, hind pair membranous. Have a pair of pincers on end of abdomen. Found on plants, decayed matter and sometimes in houses.

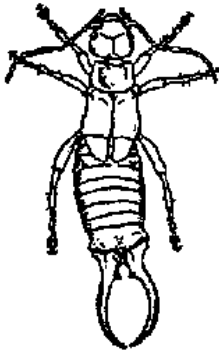

Reddish-brown; foul odor; nests in decaying matter in greenhouses and buildings; feeds on organic material. About 20 species are reported in North America but all look very much alike.

Order: Plecoptera

(Stoneflies)

Wings – Two pairs

Mouthparts – Chewing

Metamorphosis – Incomplete



Added Note – Found near running streams.

Two pairs wings same thickness with 12 or more cross veins; second pair wings broader than first pair. Tarsus (foot) with less than five segments. Length 1/2 to 1 inch.

Several different species (about 300 in North America); vary in color and size. Adult probably eats nothing; immature stages found in aerated water, food for fish.

Order: Neuroptera

(Dobsonflies, Lacewings, Antlions)

Wings – Two pairs, many fine net-like veins

Mouthparts – Chewing

Metamorphosis – Complete

Dobsonfly

Order Neuroptera

wing span 5 1/2 inches

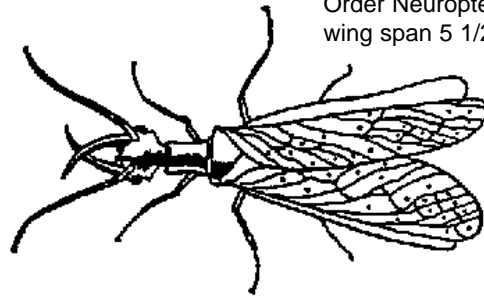

Horned adult; larva, a fish food, called hellgrammite by anglers; eats other insects.

Green Lacewing

Order Neuroptera

wing span 1 1/4 inches

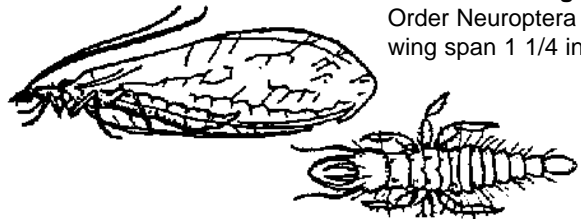

Added Note – Have long antennae. Found near streams, at lights or on trees and plants.

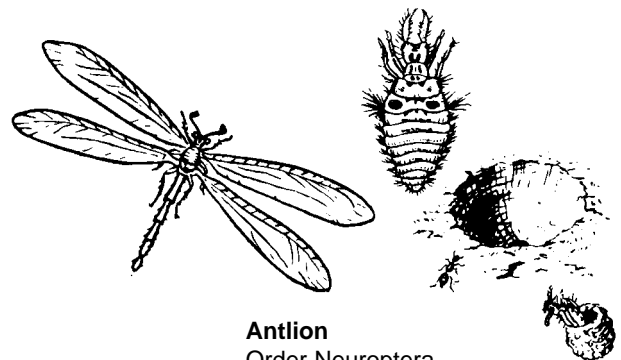

Antlion

Order Neuroptera

wing span 1 inch

Graceful adult; larva, doodlebug, digs pit, partially buries itself in bottom waiting for ant victims.

Order: Phthiraptera

(Chewing and Sucking Lice)

Wings – None

Mouthparts – Chewing and sucking

Metamorphosis – None

Added Note – Live on birds and to some extent on mammals. Feed on hair, feathers, scales and dried blood.



Cattlebiting Louse

Added Note – A sucking louse. Head narrow and long. Claws pincer-like. Feed on animals.



Hog Louse

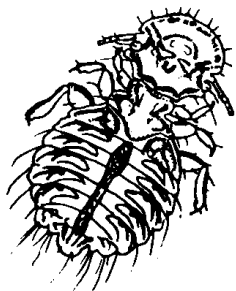

Chicken Body Louse
Order Mallophaga
length 3/16 inch

Light tan to almost black; found on chickens and other fowl; skin contact serious.

Order: Thysanoptera

(Thrips)

Wings – Two pairs or none

Mouthparts – Rasping, sucking

Metamorphosis – Gradual

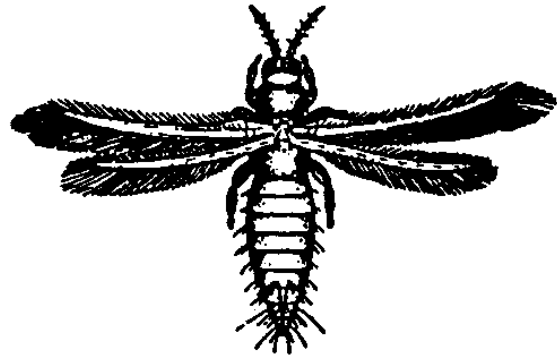

Two pairs of wings, rod-shaped and fringed with very long hairs.



Thrips
Order Thysanoptera
length 1/20 inch

Very active, minute insects with piercing, sucking mouth parts; attack all plants. Several species (about 500 in North America) include flower thrips, gladiolus thrips, onion thrips and others.

Added Note – Very small insects, only 1/8 inch long or less. Feed on many plants.

Order: Psocoptera

(Booklice and Barklice)

Wings – Some wingless,
some with two pairs

Mouthparts – Chewing

Metamorphosis – Gradual

Added Note – Found in old books and papers or
on bark of trees or on damp stored grain.

Wingless; not external
parasites of animals;
mouthparts for chewing;
no filaments or projec-
tions on tip of abdomen.

Minute, soft-bodied
insects found in old books
and damp, dark, unused
rooms. Different species
(about 150 in
North America); vary
in size.

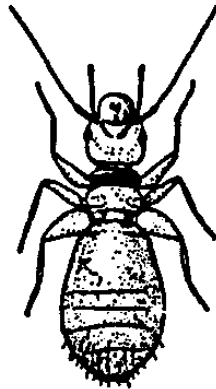

length 1/16 inch



Damsel Bug
Order Hemiptera
length 1/5 inch

Predatory insects on caterpillars and other larvae.

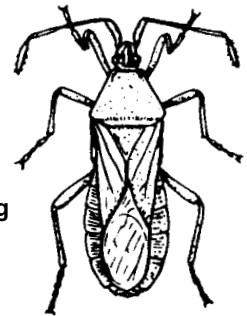

Leaf-footed or Coreid Bug
Order Hemiptera
length 1/2 to 3/4 inch

Many species include leaf-footed plant bugs,
squash bugs and others that resemble these
very closely.

Order: Hemiptera

(True Bugs)

Wings – Two pairs. Front pair is half leathery
and half membranous. Hind pair is
membranous.

Mouthparts – Piercing, sucking

Metamorphosis – Gradual

Hemiptera (true bugs): Two pairs wings; front
wing divided into two distinct sections – a
thick one toward base and a thin one at tip.
Sections are sharply divided and not just
tapered. Piercing, sucking mouthparts arising
at front-underside (anterior-ventral) part of
head. Tarsus (foot) with two claws if insect
is wingless.



Toad Bug
Order Hemiptera
length 1/2 inch

Common on muddy stream banks; protective
colors vary with soils; lives on insects.



Chinch Bug
Order Hemiptera
length 1/5 inch

Attacks small grain, corn, soybeans, St. Augustine
grass; sucks sap, wilts and kills plants; bad
odor when mashed.

Bed Bug
Order Hemiptera
length 3/16 inch



Feeds primarily on man at night; sometimes found on caged animals and birds; rests during day in cracks and dark areas.

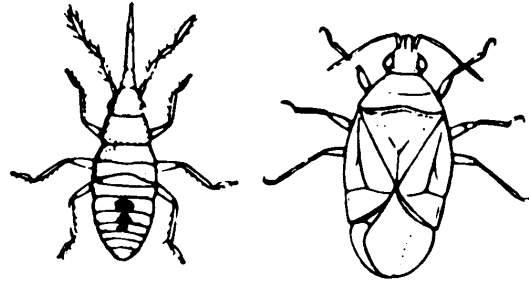

Flower Bug
Order Hemiptera
length 1/6 to 1/5 inch

Several species include insidious flower bug, predaceous flower bug and others. Predators on eggs and young larvae of caterpillars.

Giant Water Bug
Order Hemiptera
length 2 3/4 inches

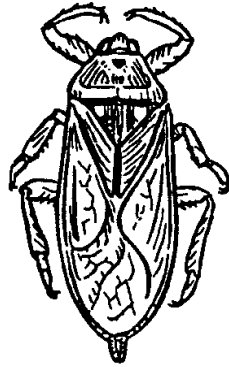

Adult, comes to light; flies from pond to pond, living on insects, snails and small fish.

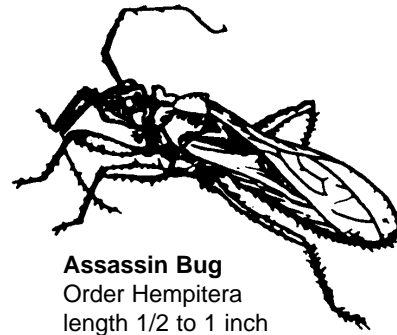

Assassin Bug
Order Hemiptera
length 1/2 to 1 inch

Several species include wheel bug, masked hunter, bloodsucking cone nose and others. Mostly predaceous on other insects; few species are bloodsucking.

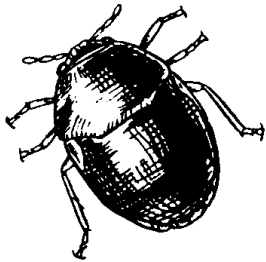

Negro Bug
Order Hemiptera
length 1/10 inch

Dark, beetle-like adult; injures celery, corn, wheat and other plants; deposits bad odor.

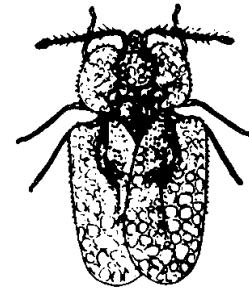

Lace Bug
Order Hemiptera
length 1/16 to 1/8 inch

Several species (about 100 in North America); include sycamore, egg plant and other lace bugs. Suck sap on undersides of leaves of shade trees and ornamental plants.

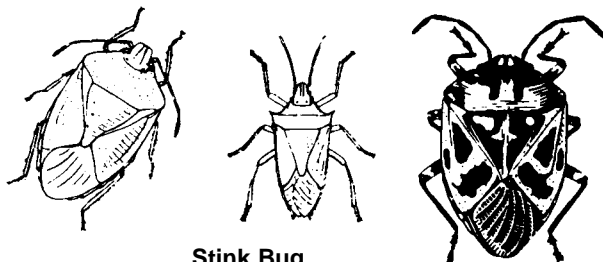

Stink Bug
Order Hemiptera
length 3/8 to 1/2 inch

Many species include harlequin bug, green stink bug, southern green stink bug, rice stink bug and brown stink bug.

Water Scorpion
Order Hemiptera
length 1 1/2 inches

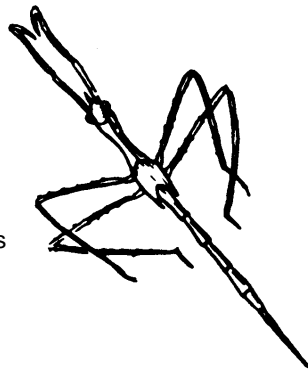

Adult lives concealed in shallow water; breathes by keeping long tube at water surface.

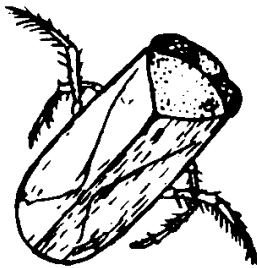

Water Boatman
Order Hemiptera
length 1 1/2 inches

Lives in ooze, feeds on minute animals at pond bottom; air bubbles surround swimming body and glisten like silver.

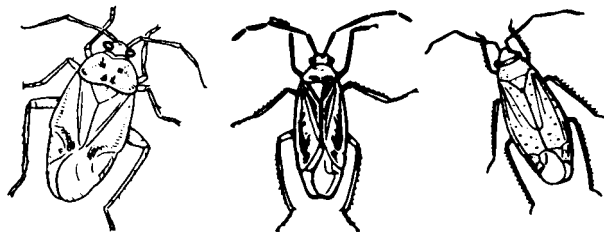

Plant Bug
Order Hemiptera
length 1/8 to 1/2 inch

Many species; includes tarnished plant bug, rapid plant bug, cotton fleahopper and others. Flattened bugs suck sap from plants, usually terminal growth or first buds.

Ambush Bug
Order Hemiptera
length 1/2 inch



Predatory bugs feed on other insects. Several different species but resemble each other closely.

Added Note – Most live on land but a few live in the water. Most feed on plant juices, but there are some which feed on animals and others which feed on other insects.

Order: Homoptera

(Aphids, Scales, Leafhoppers, Cicadas)

Wings – Two pairs or wingless

Mouthparts – Piercing, sucking

Metamorphosis – Gradual

Wingless or two pairs of wings, same thickness; piercing-sucking mouthparts arising at back underside (posterior-ventral) part of head.

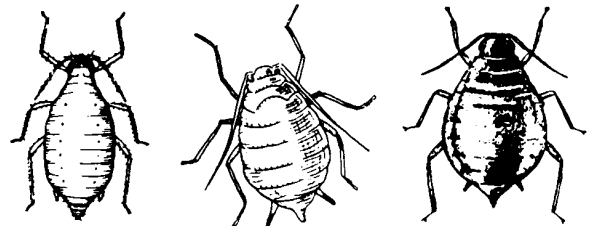

Aphid
Order Homoptera
length 3/32 inch

Minute, soft-bodied, green, red or black insects; attack vegetation; suck plant juice, secrete honeydew. Many species (probably several hundred in Arkansas); include turnip, peach, wooly, greenbug, corn leaf, apple grain and many others.



Scale
Order Homoptera
length 1/12 to 1/2 inch

Disk-shaped specks on tree bark; decreases vigor, causes thin foliage. Many species (more than 2,000); include San Jose, scurfy, oystershell, euonymus, obscure, elm, cottony cushion scale, mealybug, lecanium and others.

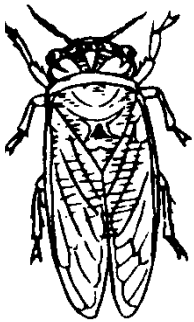

Cicada
Order Homoptera
length 1 1/4 inches

Shrill cry familiar in late summer; several species include periodical and annual cicada.

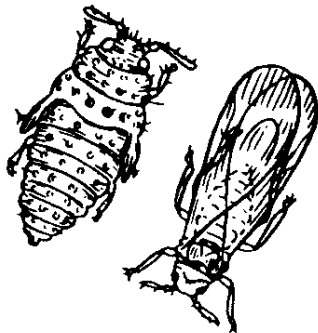

Phylloxera
Order Homoptera
length 1/24 inch

Complicated biology; injures roots and foliage with galls, causes tissue disintegration. Includes grape and pecan phylloxera.

Psyllid
Order Homoptera
length 1/8 inch

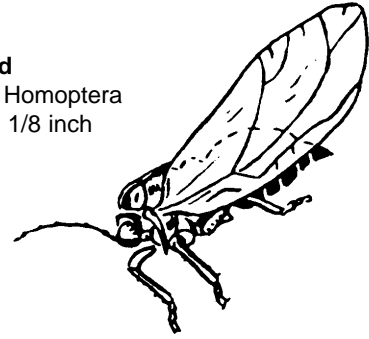

Hopping insect resembles winged aphid; carries plant disorder more damaging than its feeding.



Whitefly
Order Homoptera
length 1/25 inch

Snow-white adult and pale-green nymph cover many plants, suck sap, destroy vigor. Species include greenhouse, citrus and other whiteflies.

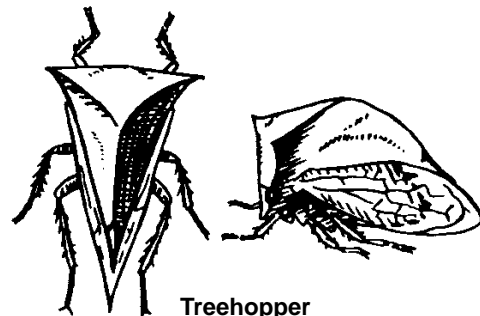

Treehopper
Order Homoptera
length 1/4 inch

Peculiar-shaped, light-green to multi-colored; adult slits bark, depositing eggs; nymph feeds on vegetation. Several species in Arkansas.

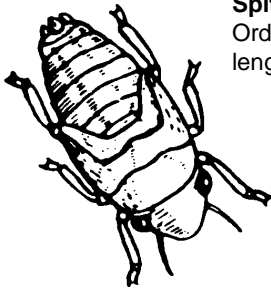

Spittlebug or Froghopper
Order Homoptera
length 1/4 inch

Several different species; attack legumes, trees and shrubs; feeds in frothy mass of sap.

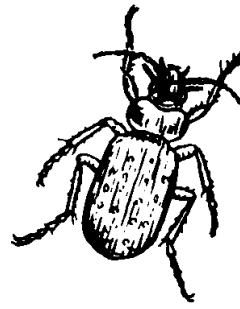

Ground Beetle
Order Coleoptera
length 1/4 to 1 inch

Very large number of species (more than 2,500 in United States); with wide variation in color, size and shape. Very common everywhere; feed on other insects.

Leafhopper
Order Homoptera
length 1/8 to 3/8 inch



Many species; vary in color; include potato leafhopper, bean leafhopper and others. Sucks juices from plants, causes hopper burn; found on underside of leaves, transmits many of the plant virus diseases.

Tiger Beetle
Order Coleoptera
length 1/2 to 3/4 inch

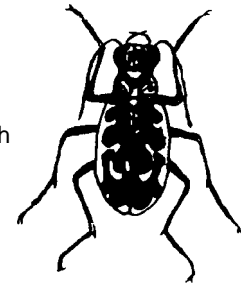

Several species are known; all are bright metallic colored; found in dry sandy fields and beaches. Predatory on other insects.

Order: Coleoptera

(Beetles)

Wings – Two pairs

Front pair – Hard and shell-like

Hind pair – Membranous

Mouthparts – Chewing

Metamorphosis – Complete

Added Note – Two pairs of wings; front wings hard and strong, forming a shell on the back and divided by thin line down the center; mouthparts for chewing.

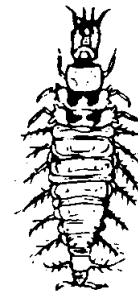
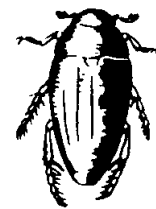

Water Scavenger Beetle
Order Coleoptera
length 1 1/2 inch

Many species may be collected. Common in quiet pools; swims or crawls on plant life; feeds on decaying material in water.

Carrion Beetle
Order Coleoptera
length 1/2 to 1 1/2 inches



Several species in Arkansas; vary in size and color. Buries dead animals in which eggs are deposited; adult, larva feed on decaying animal matter.

Flatheaded Borer
Order Coleoptera
length 1/2 to 1 inch



Several species in Arkansas; wood boring insects; adult metallic colored; includes flatheaded apple tree borer.

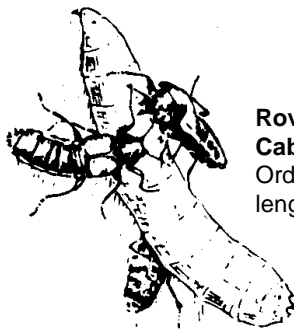

Rove Beetles Attacking Cabbage Maggot
Order Coleoptera
length 1/4 to 1 inch

Several species (more than 1,000); black adults; feed on fly maggots; common about decaying animal or vegetable matter.

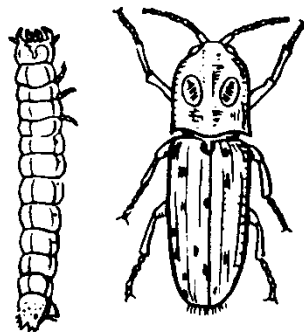

Click Beetle
Order Coleoptera
length 1/2 to 1 1/2 inches

Many species (more than 500 in North America); vary in size and color. Make clicking noise when placed on back; occur on flowers, under bark and on vegetation. Larvae are wireworms.

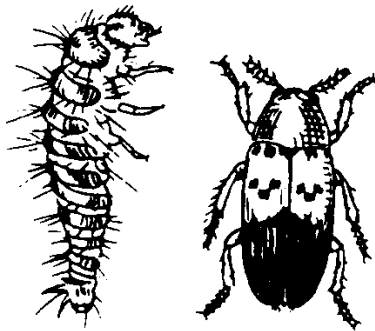

Dermestid Beetle
Order Coleoptera
length 3/16 to 1/3 inch

Several species in Arkansas; includes carpet beetles that feed on woolen material and larder beetles, a pest of meat and animal products.

Powderpost Beetle
Order Coleoptera
length 1/8 to 1/2 inch

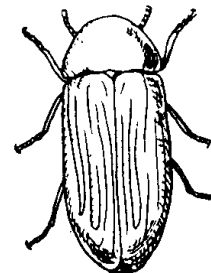

Several different species (about eight); feed in wood and lumber. Adults are slender and leave holes in flooring and furniture when emerging.



Leaf Chafer
Order Coleoptera
length 1/4 to 1/2 inch

Many species in this group; include Japanese beetle, rose chafer and grape beetle. Most are metallic colored and found feeding on plants.



Darkling Beetle
Order Coleoptera
length 1/4 to 3 inches

The many species (about 1,400 in North America) are mostly plant feeders found cutting off seedlings at soil line; confused flour beetle is a grain pest.

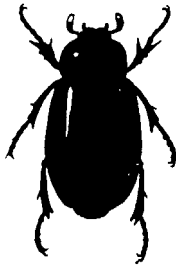

May Beetle
Order Coleoptera
length 1/4 to 3/4 inch

Many different species (150 in the United States) of May beetles. To this group belong the light to dark brown beetles collecting around lights at night.

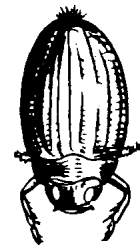

Whirligig Beetle
Order Coleoptera
length 3/4 inch

Groups spin or dart rapidly on still water; some emit fluid with disagreeable odor; feed on aquatic creatures.



Dung Beetle
Order Coleoptera
length 1/4 to 1 inch

Many species in Arkansas; most are black but some are metallic green. Found feeding on dung. Most common species are found rolling ball of dung prior to burying it in the ground.

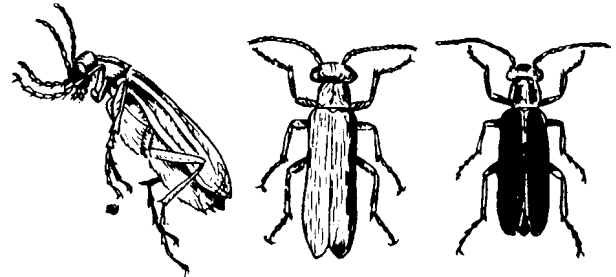

Blister Beetle
Order Coleoptera
length 1/2 to 3/4 inch

Many species (about 300 in North America) include striped, margined, black, ash gray and others. All resemble each other in appearance though they vary in color. Feed on various vegetables and field crops.



Rhinoceros Beetle
Order Coleoptera
length 1 to 2 1/2 inches

Several species in Arkansas; brown to gray with black markings; includes the unicorn beetle, elephant beetle and rhinoceros beetle.



Carrot Beetle
Order Coleoptera
length 5/8 inch

Adult feeds on corn and celery stalks, potato and carrot roots; larva is scavenger.

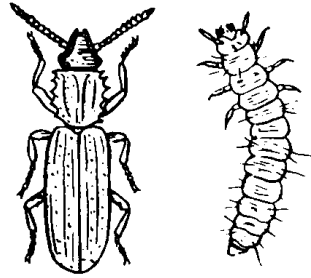

Saw-toothed Grain Beetle
Order Coleoptera
length 1/10 inch

Beetle often found in stored food and dry organic matter; adult and larva serious pests.

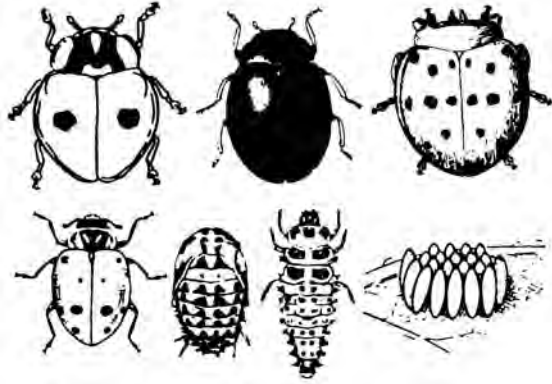

Lady Beetle
Order Coleoptera
length 1/16 to 1/4 inch

Many species in Arkansas; include black lady beetle, two-spotted lady beetle, convergent lady beetle and others that feed on other insects. Mexican bean beetle and squash lady beetle feed on plants.



Cadelle
Order Coleoptera
length 1/3 inch

Found in granaries, mills, ships, railroad cars; attacks stored grain, other dry food products; larva often bores woodwork.

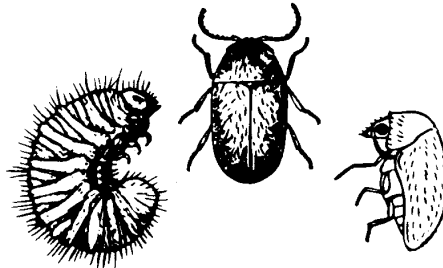

Cigarette or Tobacco Beetle
Order Coleoptera
length 1/3 inch

Adult light brown; serious pest to tobacco and infests other stored products; widespread.

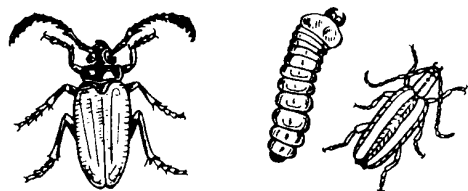
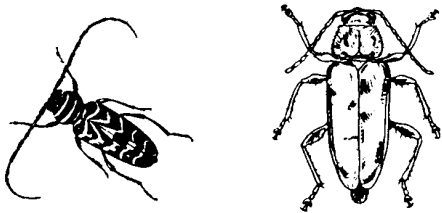

Long-horned Beetle
Order Coleoptera
length 1/3 to 1 1/2 inches

Many species (over 1,500 in the United States); include locust borer, cottonwood borer, prionus, twig girdler, sawyer beetle and others. Found around living trees in the bark crevices where they lay eggs. Larvae are round-headed borers.

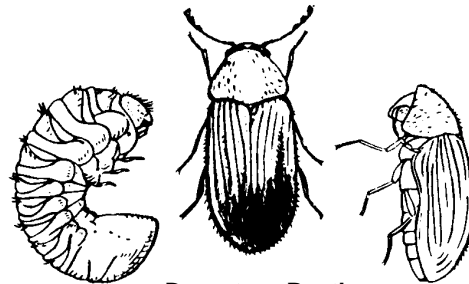

Drugstore Beetle
Order Coleoptera
length 1/10 inch

Adult reddish brown, named for serious feeding on pharmaceutical drugs; infests most dry plant and animal products.

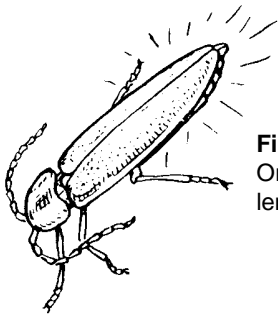

Firefly or Lightning Bug
Order Coleoptera
length 1/2 inch

Elongate, flattish; appears at night; both sexes emit light; larva called glowworm.

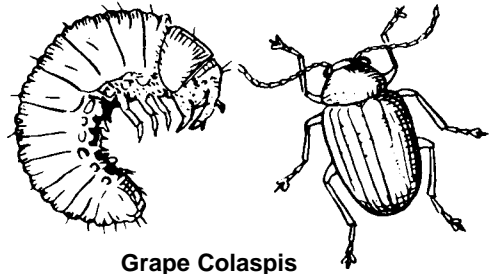

Grape Colaspis
Order Coleoptera
length 1/6 inch

Adult flies about crops, feeds on foliage; grub, root-feeder; also known as clover rootworm.



Giant Stag Beetle
Order Coleoptera
length 2 inches

Mandibles resemble stag antlers; night flier; attracted to lights; larva lives in decaying wood.

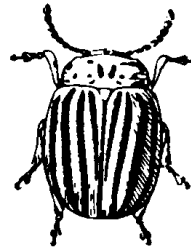

Colorado Potato Beetle or Potato Bug
Order Coleoptera
length 3/8 inch

Yellow and black striped adult; larva reddish orange soft bug; feed on potato vines, other plants.



Flower Beetle
Order Coleoptera
length 1/4 to 3/4 inch

Several species, most common of which is the green June beetle and the bumble-flower-beetle. These are found feeding on pollen or very ripe fruit or decaying fruit or plant material.

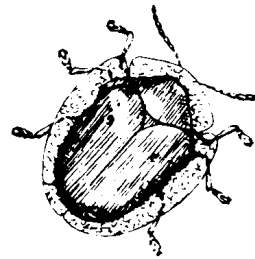

Tortoise Beetle or Gold Bug
Order Coleoptera
length 1/4 inch

Turtle-shaped adult and thorny larva feed on sweet potato foliage, morningglory, bindweed.

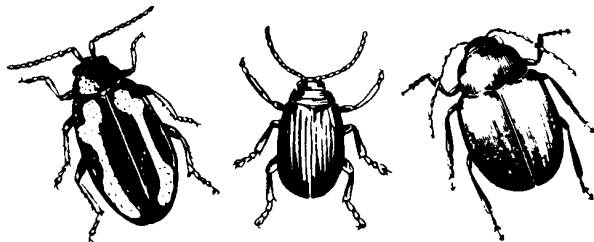

Flea Beetle
Order Coleoptera
length 1/16 to 1/4 inch

Several different species in Arkansas, including striped flea beetle, grape flea beetle, potato flea beetle; adult jumps about, feeding on foliage, severely damaging plant; larva feeds on roots.

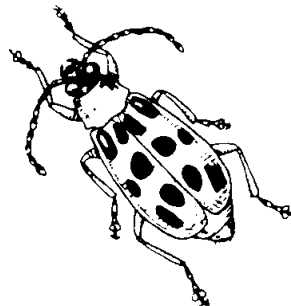

Spotted Cucumber Beetle
Order Coleoptera
length 1/4 inch

Yellowish green, black-spotted; attacks many plants; larva bores roots and underground stems.

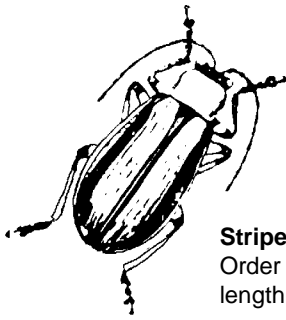

Striped Cucumber Beetle
Order Coleoptera
length 1/5 inch

Adult general foliage-feeder, spreads disease;
larva mines plant roots and stems.



Ambrosia Beetle
Order Coleoptera
length 1/8 inch

Several species; female tunnels oak; grows
ambrosia fungi for food; keeps larva under
protective care.



Bean Leaf Beetle
Order Coleoptera
length 1/6 inch

Reddish, yellowish adult eats holes in leaves;
larva feeds on roots.

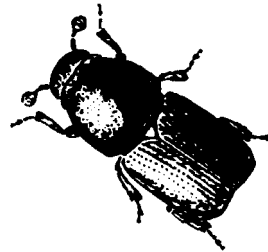

Bark Beetle
Order Coleoptera
length 1/4 inch

One of the most destructive groups of insects
attacking coniferous trees; includes southern
pine beetle, black turpentine beetle; mines
under bark; many transmit fungi.



Asparagus Beetle
Order Coleoptera
length 1/4 inch

Cream, bluish-black, red adult deposits eggs on
plant stems; larva feeds on, stains asparagus.



Engraver Beetle
Order Coleoptera
length 1/5 inch

Bark beetle; several species; include *Ips* sp.; lay
eggs in inner bark tunnels, where larva
develop and feed.

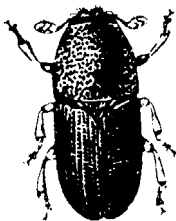

Shot-hole Borer
Order Coleoptera
length 1/10 inch

Beetle deposits eggs in twigs, branches; larva
tunnels with grain or wood, exit holes look
like shot-holes.

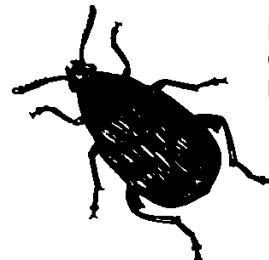

Bean Weevil
Order Coleoptera
length 1/8 inch

Adult appears on plants, depositing eggs; larva
feeds on beans in field and in storage.

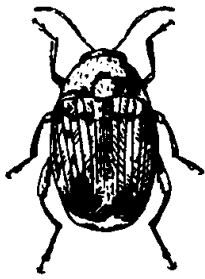

Pea Weevil
Order Coleoptera
length 1/5 inch

One of worst pests to peas; dark brown or blackish adult feeds on leaves; larva develops in growing pods.



Cowpea Curculio or Pod Weevil
Order Coleoptera
length 1/4 inch

Hump-backed weevil damages beans, cowpeas, seedling cotton, strawberries; grub develops in green seeds.



Vegetable Weevil
Order Coleoptera
length 3/8 inch

Spotted, grayish adult damages foliage of many plants; grub feeds on plant roots.

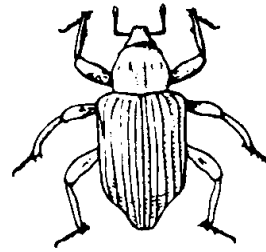

Rice Water Weevil
Order Coleoptera
length 1/8 inch

Adult feeds on leaves; larva tunnels and feeds on roots.

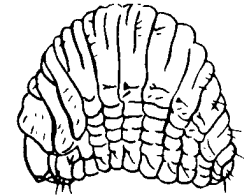
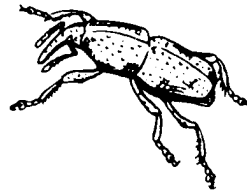

Rice Weevil
Order Coleoptera
length 1/8 inch

Attacks corn in field and many stored grain products; many generations a year possible.

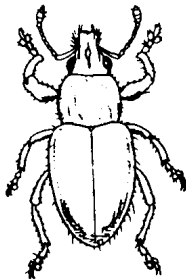

White-fringed Beetle
Order Coleoptera
length 1/2 inch

General plant feeder in southeast United States; no males; larva or grub serious pest to plant roots.

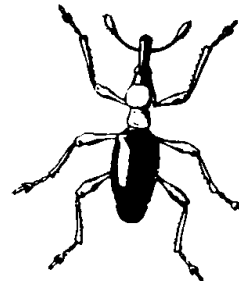

Sweet Potato Weevil
Order Coleoptera
length 1/4 inch

Bad pest of sweet potato; blue-black and red adult feeds on leaves, stems; grub honeycombs tubers in field and storage.

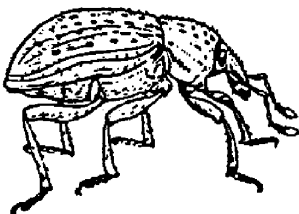

Clover Leaf Weevil
Order Coleoptera
length 5/16 inch

In dry seasons may destroy alfalfa plantings; larva curves body with head and tail almost touching.

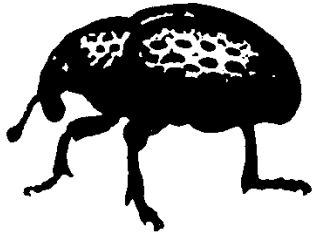

Strawberry Crown Borer
Order Coleoptera
length 1/5 inch

Larva tunnels through strawberry crowns, stunting or killing plants.

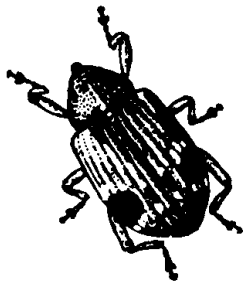

Strawberry Weevil
Order Coleoptera
length 1/8 inch

Damages strawberries, other plants; feeds in buds and stems, causing fruit reduction.

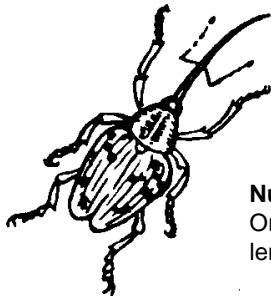

Nut Weevil
Order Coleoptera
length 5/16 inch

Several species attack different nuts; long, curving beak bores in nut, deposits eggs singly; maggot-like larva forms on kernel.



Boll Weevil
Order Coleoptera
length 1/4 inch

Serious pest to United States cotton; grub and beetle feed on squares, bolls or terminal buds.

Plum Curculio
Order Coleoptera
length 1/4 inch

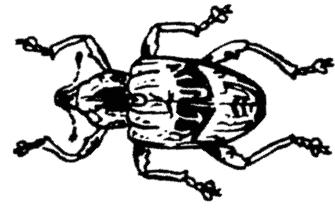

Pest of stone fruits, apple; adult feeds on fruit, foliage; grub feeds inside fruit.

Order: Mecoptera (Scorpionflies)

Wings – Two pairs, long and narrow

Mouthparts – Chewing

Metamorphosis – Complete

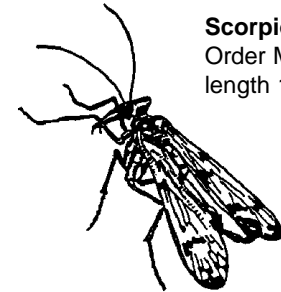

Scorpionfly
Order Mecoptera
length 1 inch

Added Note – Mouthparts at the end of long, broad snout. Found on low vegetation in dense woods or sometimes in open fields.

Two pairs of wings, same thickness with 12 or more cross veins; tarsus (foot) with five segments; head prolonged into a long beak. Hangs suspended by fore legs from rank herbage; hind and fore legs catch living insects. Found along shaded streams and in damp woods; feeds on dead or injured insects.

Order: Trichoptera (Caddisflies)

Wings – Two pairs

Mouthparts – Chewing

Metamorphosis – Complete

Added Note – Wings covered with short hairs and held roof-like over body when at rest. Found near water.



Two pairs of wings alike in thickness, with less than 12 cross veins. Front pair of wings as small or smaller than back pair.

Mouthparts small and inconspicuous.

Distinguished from moths by having hairs instead of scales on wings.

Order: Lepidoptera

(Butterflies, Moths, Skippers)

Wings – Two pairs

Mouthparts – Siphoning

Metamorphosis – Complete

Two pairs of wings alike in thickness; wings or wing veins clothed with scales appearing as “dust” when roughly handled.



Armyworm
Order Lepidoptera
wing span 1 1/2 inches

Pale brown or brownish-gray with white dot in front wing center; larva very destructive.

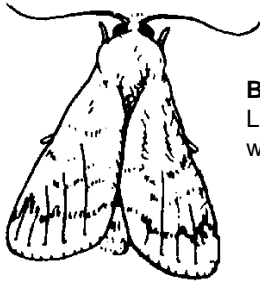

Bollworm
Lepidoptera
wing span 1 1/2 inches

Yellowish to brownish; larva infests many plants; known also as corn earworm, tomato fruitworm, tobacco budworm.

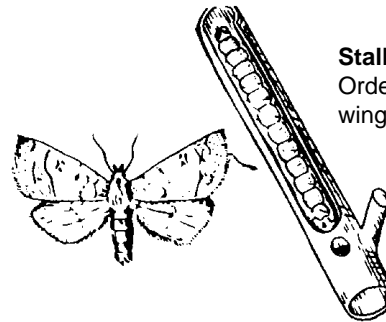

Stalk Borer
Order Lepidoptera
wing span 2 inches

Several different stalk borers; include lesser stalk borer, European corn borer and south-western corn borer. Caterpillar bores into stems, feeding on heart of plant; migrates about field.

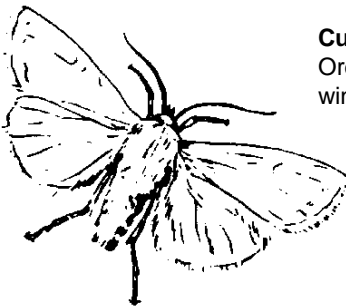

Cutworm
Order Lepidoptera
wing span 2 inches

Several species in Arkansas; night-flying moths attracted to lights; varying colors; larva cuts plants off near soil surface.

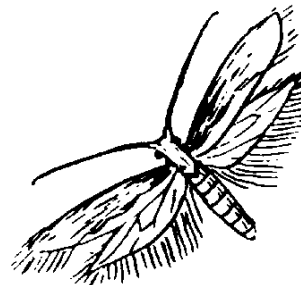

Diamondback Moth
Order Lepidoptera
wing span 5/8 inch

About 50 species in North America; gray; male fore wings yellow-striped to form diamond shapes; larva is plant-feeder.

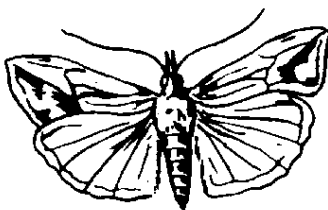

Green Cloverworm
Order Lepidoptera
wing span 1 1/4 inches

Dark brown moth; slender, greenish larva attacks legumes and other crops.

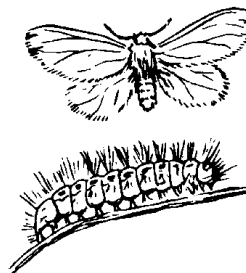

Fall Webworm
Order Lepidoptera
wing span 1 1/4 inches

Hairy caterpillar, spins dirty-white web on shade trees and shrubs, feeding on foliage.

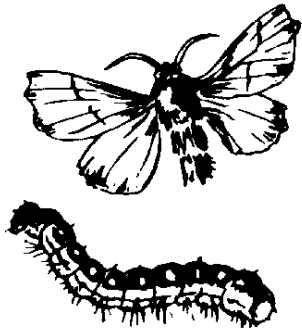

Forest Tent Caterpillar or Forest Armyworm
Order Lepidoptera
wing span 3 1/2 inches

Larva defoliates many shade and forest trees.



Oriental Fruit Moth
Order Lepidoptera
wing span 3/8 inch

Attacks peach, apple, other fruit trees; early larvae tunnel twigs; later ones feed in fruit.

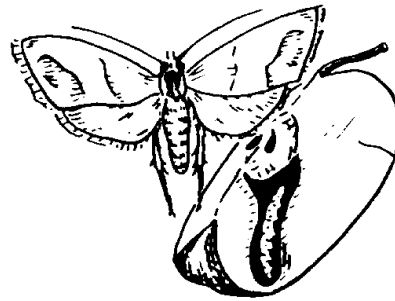

Codling Moth
Order Lepidoptera
wing span 3/4 inch

Most important pest of apple; larva feeds in fruit until full-grown.

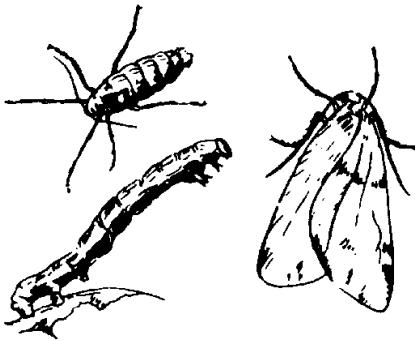

Cankerworm
Order Lepidoptera
wing span 1 1/4 inches

Male moth, wingless female; larva feeds on fruit and other trees; spring cankerworm is similar species.

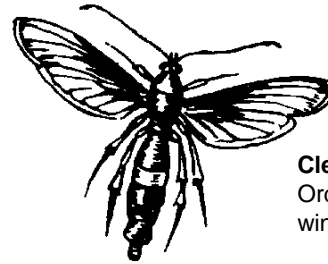

Clearwing Moth
Order Lepidoptera
wing span 1 1/4 inches

About 100 species in North America; wings have transparent areas; larva chews into woody plant parts; includes peach tree borer and grape root borer.



Sphinx Moth
Order Lepidoptera
wing span 2 to 4 inches

Several species include tomato hornworm, tobacco hornworm, catalpa sphinx and others. Adults feed on nectar from flowers. Resemble hummingbirds when flying early at night.

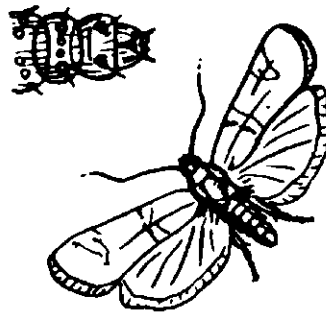

Apple Leaf Skeletonizer
Order Lepidoptera
wing span 1/2 inch

Late summer and early fall injury to trees by dark green, active caterpillar feeding in web.

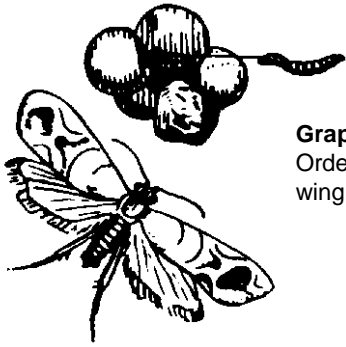

Grape Berry Moth
Order Lepidoptera
wing span 2/5 inch

Larva spins silken web over grape clusters; feeds in and destroys grape berries.



Redbanded Leaf Roller
Order Lepidoptera
wing span 3/4 inch

Early larvae roll leaves and spin slight webs; later generations attack fruit.



Angoumois Grain Moth
Order Lepidoptera
wing span 1/2 inch

Weathered straw-colored adult; larva, dangerous common pest, infests grains in field, storage.

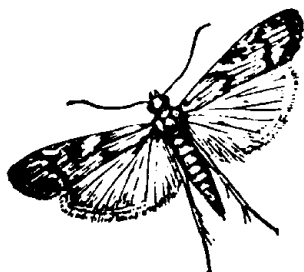

Mediterranean Flour Moth
Order Lepidoptera
wing span 1 inch

Larva prefers flour and meal, attacks other foodstuff; webs masses of flour in mills.

Indianmeal Moth
Order Lepidoptera
wing span 3/4 inch

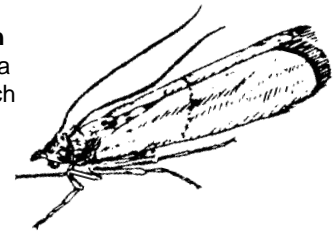

Pest of stored foods, grain; larva spins silken tubes through meal, dried fruits and other products.



Melonworm or Pickleworm
Order Lepidoptera
length 1 1/4 inches

Translucent, yellowish-green larva feeds on leaves, fruit of cucurbits; adult, iridescent, pearly-white, black-bordered.

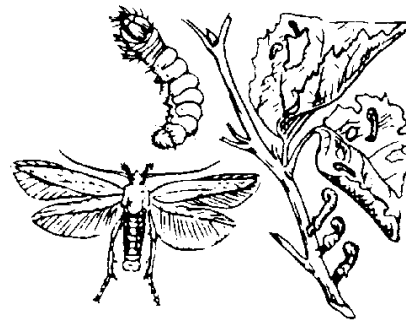

Pistol Casebearer
Order Lepidoptera
wing span 1/2 inch

Brown worm enclosed in curved, silken case; eats holes in leaves, buds and fruits of apple, pear, cherry, plum, other trees.

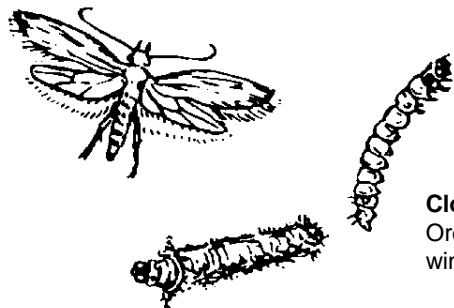

Clothes Moth
Order Lepidoptera
wing span 1/2 inch

Adult flies about, depositing eggs; larvae feed on fabrics, some forming webs, some cases.

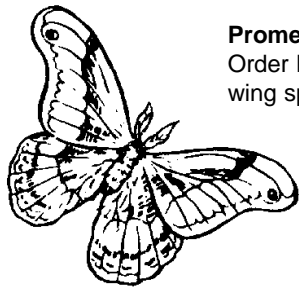

Promethea Moth
Order Lepidoptera
wing span 4 inches

Giant silkworm; reddish-brown, whitish and black lines, clay-colored margin; cocoons common sight in trees.

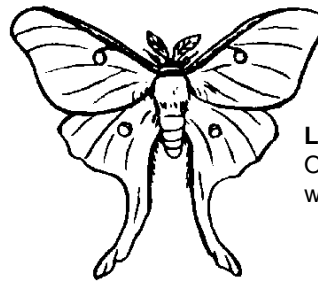

Luna Moth
Order Lepidoptera
wing span 4 1/2 inches

Favorite with amateur collectors; delicate light green with purple-brown band and transparent-center eyeslike spots.

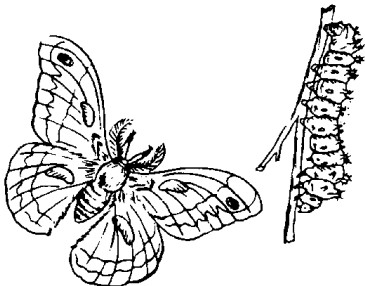

Cecropia Moth
Order Lepidoptera
wing span 7 inches

Pale green, red and yellow larva feeds on foliage of apple, other trees and shrubs.



Black Witch
Order Lepidoptera
wing span 6 inches

Night-flying moth attracted by lights; eyes shine in darkness; larva feeds on tree leaves.

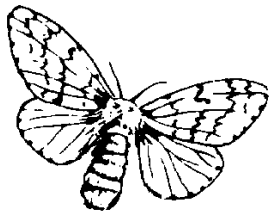

Gypsy Moth
Order Lepidoptera
wing span 2 inches



Serious pest of evergreen and deciduous trees; larva strips foliage, often killing trees.



Tiger Swallowtail Butterfly
Order Lepidoptera
wing span 5 inches

Magnificent, tail-like edges on hind wings; black marked with yellow, blue or green.

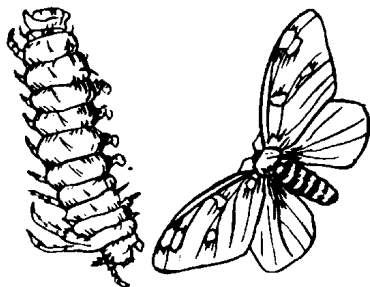

Regal Moth
Order Lepidoptera
wing span 5 inches

Magnificent royal moth; olive, yellow, red, orange-red; larva, hickory horned devil, feeds on leaves of trees and shrubs.



Zebra Swallowtail Butterfly
Order Lepidoptera
wing span 3 1/2 inches

Black wings are crossed by several bands of greenish-white; larva feeds on pawpaw.



Monarch Butterfly
Order Lepidoptera
wing span 4 inches

Ruddy brown, black-bordered; white-spotted;
larva feeds on milkweed; distasteful to birds.

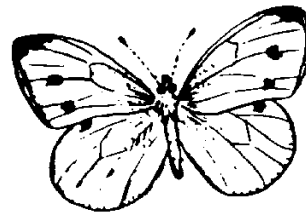

Cabbage Butterfly
Order Lepidoptera
wing span 1 1/4 inches

One of the most common butterflies; wings
are dull-white with black spots; larva is
plant feeder.



Viceroy Butterfly
Order Lepidoptera
wing span 3 inches

Orange to cinnamon with black, white-spotted;
mimics monarch in detail, perhaps for
protection.

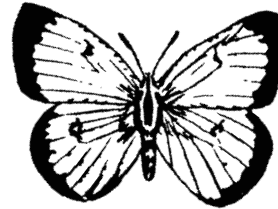

**Clouded Sulphur or
Roadside Butterfly**
Order Lepidoptera
wing span 2 inches

Pale greenish-yellow, blackish-brown border;
underside sulphur-yellow; found in
muddy places.



Great Spangled Fritillary
Order Lepidoptera
wing span 4 inches

Tawny, black-checked, silvery-spotted; Latin
name means dice box; larva feeds on
passion flowers.

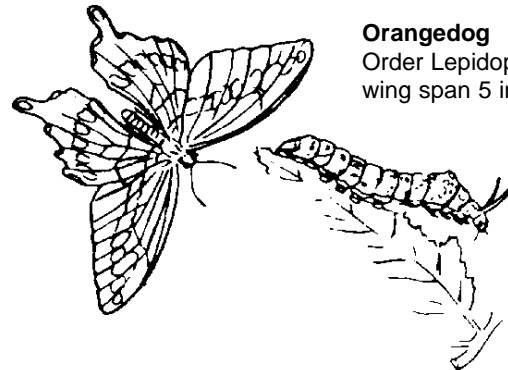

Orangedog
Order Lepidoptera
wing span 5 inches

Larva feeds on orange tree, prickly ash foliage;
red, protruding horns, emit bad odor.



Painted Lady
Order Lepidoptera
wing span 2 1/4 inches

Dark brownish-black, orange; eyelike spots on
hind wings; larva feeds on composite plants.



Red Admiral
Order Lepidoptera
wing span 2 1/4 inches

Purplish-black, bright orange band, white spots;
larva feeds on certain tree leaves.



Giant Skipper
Order Lepidoptera
wing span 3 inches

Daytime flier with rapid, darting flight; rests wings vertically; larva, stem-borer.

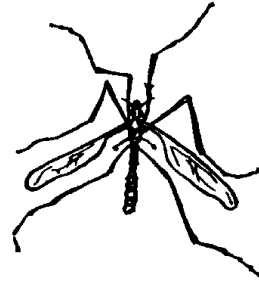

Crane Fly
Order Diptera
length 1/2 to 2 inches

Many different species; resembles large mosquito. Found in damp, dark places, around water or in windows of houses; some come to lights.

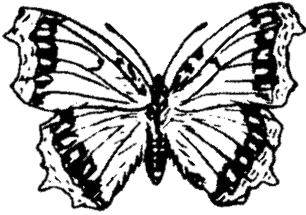

Mourningcloak Butterfly
Order Lepidoptera
wing span 2 3/4 inches

Purplish-brown, yellow border, brown and blue spotted; larva feeds on tree leaves, known to strip large branches.

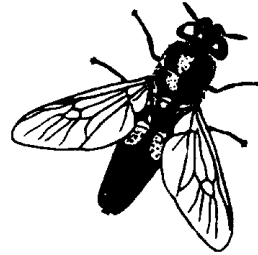

Soldier Fly
Order Diptera
length 3/4 inch

Adult widespread; larva may invade human body, causing intestinal myiasis.

Order: Diptera

(Flies, Mosquitoes, Midges)

Wings – One pair

Mouthparts – Piercing, sucking or sponging

Metamorphosis – Complete

One pair of wings, membranous, similar to cellophane in appearance.

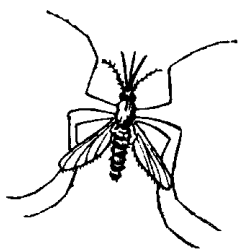

Mosquito
Order Diptera
length 3/16 to 3/8 inch

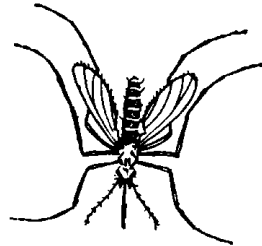

Cheese Skipper
Order Diptera
length 3/16 inch

Shiny fly; larva infests meat, cheese, other foods; bends body double to leap; world-wide.

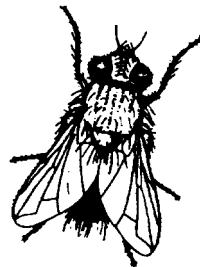

Tachinid Fly
Order Diptera
length 1/4 to 3/8 inch

Many species (more than 100 in United States), include rice field, southern house, malaria, yellow fever, salt-marsh and others. Larvae live in water; adult females suck blood for food.

Many species in Arkansas; parasitic on other insects.

March Fly
Order Diptera
length 1/2 inch



Several species; adults common in early spring; fly in swarms; larva feeds on decaying matter or grass roots.



Black Fly, Turkey or Buffalo Gnat
Order Diptera
length 1/5 inch

Several species in Arkansas; small, dark-colored flies with short legs and hump-backed appearance; larvae live in water; female adults suck blood and are serious pests of livestock in some areas of Arkansas.



Window-pane Fly
Order Diptera
length 3/16 inch

Often found around windows of mills and warehouses; preys on stored-grain insects.

Midge
Order Diptera
length 2/5 inch



Many species in the United States; appearance like very small mosquito. All live around water or in mud; some species, like the punkies, suck blood. These are very annoying in Arkansas in early morning and evening during spring.



Robber Fly
Order Diptera
length 1 to 2 inches



Many species (more than 500 in North America); large, fierce fly capable of fast flight; adult, larva feed on insects including large species.

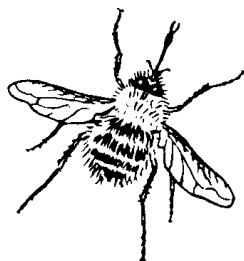

Bee Fly
Order Diptera
length 1/2 inch

Adult feeds on flower nectar; about 500 species known in United States; rests on sunny paths, sticks or stones; larva feeds on insects.

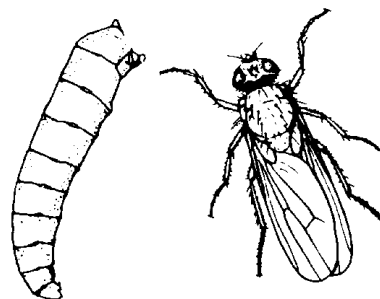

Seedcorn Maggot
Order Diptera
length 1/4 inch

Legless, yellowish-white grub with tough skin; severely damages seedlings; grows into adult fly.

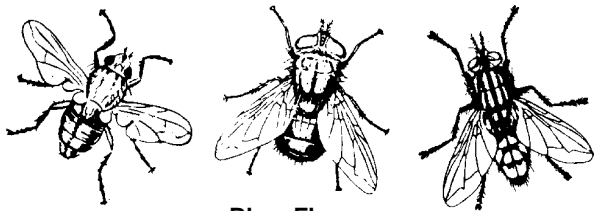

Blow Fly
Order Diptera
length 5/16 inch

Many species including green-bottle fly and blue-bottle fly. Many are metallic green or blue in color. Flesh flies are black with stripes. Larvae live in carrion or decaying animals. Screwworm fly is parasitic and lives in living flesh.

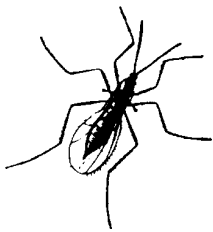

Hessian Fly
Order Diptera
length 1/8 inch

Wheat, barley, rye are preferred food; legless, headless maggots feed on plant sap.



Sheep Bot Fly
Order Diptera
length 1/2 inch

Adult deposits larvae in nose of sheep and goats, maggots develop in sinus area.



Horse Bot Fly
Order Diptera
length 2/3 inch

Adult annoys livestock by buzzing flight; larva lives in digestive tract of livestock.

**Sheep Tick,
Louse Fly or Ked**
Order Diptera
length 1/4 inch

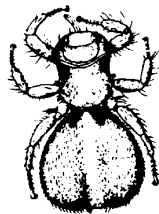

Wingless fly; lives in fleece of host, sucking blood through skin; attacks goats, sheep.



House Fly
Order Diptera
length 1/4 inch

Common in dwellings nation-wide; deposits eggs in manure; disease carrier.

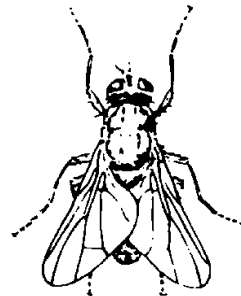

Horn Fly
Order Diptera
length 3/16 inch

Annoying, bloodsucking pest of cattle; deposits eggs in fresh cattle droppings.



Stable Fly
Order Diptera
length 1/4 inch

Looks like house fly; attacks animals and man; bites, especially on legs.



Horse Fly and Deer Fly
Order Diptera
length 1/2 to 1 1/4 inches

Many species (about 300 in North America); attacks man and animals in woods or marshes; painful bite.

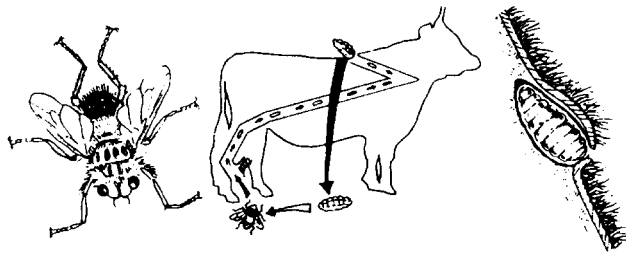

Cattle Grub, Heel or Warble Fly
Order Diptera
length 7/16 inch

Adult deposits eggs on cattle hairs; maggots live in body, bore out back, fall to ground, pupate in soil.

Order: Siphonaptera

(Fleas)

Wings – None

Mouthparts – Piercing, sucking

Metamorphosis – Complete

Added Note – Live on animals. Collect them by dusting a cat or dog with pyrethrum powder and place the animal over a white cloth. Fleas will drop off on cloth.

Wingless; external parasites of birds and mammals; body strongly compressed from side to side; legs fitted for jumping.

Several species (about 1,100 known worldwide); adult bites dogs, cats, man; common; may infest dwellings.



Order: Hymenoptera

(Bees, Wasps, Ants)

Wings – Two pairs. Worker ants are wingless.

Mouthparts – Chewing

Metamorphosis – Complete

Two pairs of wings the same thickness with less than 12 cross veins; first pair of wings larger than second and mouthparts well developed.

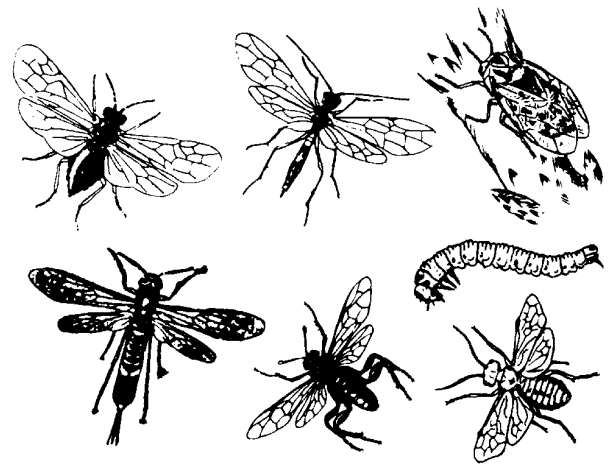

Sawfly
Order Hymenoptera
length 1/2 to 1 1/2 inches

Many species of sawflies in Arkansas, including web-spinning sawflies, pine sawflies, horntails, wood wasps, stem sawflies, sawfly leaf miners and others.



Honey Bee
Order Hymenoptera
length 3/4 inch

Builds nest in hollow trees or man-provided hives; collects pollen, produces honey, pollinates many crops.

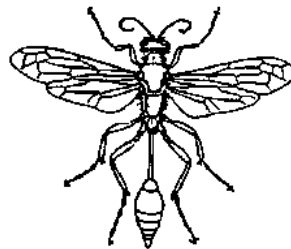

Mud Dauber
Order Hymenoptera
length 1 1/2 inches

Several species in Arkansas; vary in color. Makes mud nest on lower surface of stones or buildings; feeds young on spiders or caterpillars.



Bumble Bee
Order Hymenoptera
length 1 1/2 inches

Social family with queen, workers, males; queen often builds in deserted ground nests of mice; pollinators.

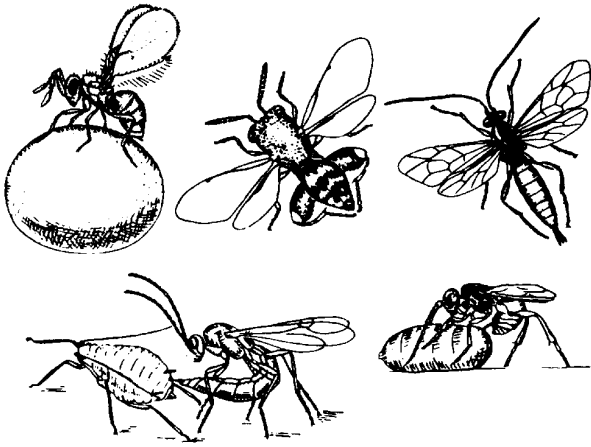

Parasitic Wasp
Order Hymenoptera
length 3/4 to 1 1/2 inches

Many species (more than 6,000) which are parasites on other insects. Some are very tiny parasitizing aphids and some are large parasitizing wood borers.

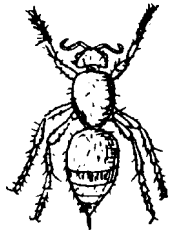

Wingless Wasp or Velvet Ant
Order Hymenoptera
length 1 1/3 inches

Several species in Arkansas; most clothed in velvet-like hairs; guest or parasite in nests of wasps or bees; strong stinger.



Baldfaced Hornet
Order Hymenoptera
length 1 inch

Builds large, grayish, paper nest on tree limbs and buildings; feeds on insects; vicious stinger.

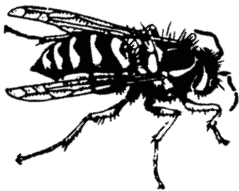

Yellowjacket
Order Hymenoptera
length 1 1/4 inches

Builds paperlike nest in ground; feeds and raises young on other insects; has painful sting.



Sphecoid Wasp
Order Hymenoptera
length 3/4 inch

Many species; nest builder in earth or dead wood; provisions nest with paralyzed insects or spiders.



Carpenter Bee
Order Hymenoptera
length 3/16 inch

Resembles bumble bee; builds solitary nest in wood or hollow stems; pollinates plants.

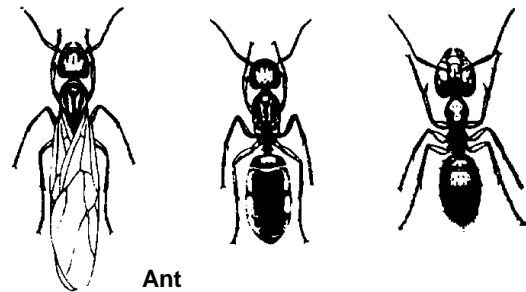

Ant
Order Hymenoptera
length 1/32 to 1/2 inch

Many different ants are common in Arkansas including carpenter ant, Pharaoh ant, southern fire ant, imported fire ant, harvester ant and others.

Printed by University of Arkansas Cooperative Extension Service Printing Services.

Issued in furtherance of Cooperative Extension work, Acts of May 8 and June 30, 1914, in cooperation with the U.S. Department of Agriculture, Director, Cooperative Extension Service, University of Arkansas. The Arkansas Cooperative Extension Service offers its programs to all eligible persons regardless of race, color, national origin, religion, gender, age, disability, marital or veteran status, or any other legally protected status, and is an Affirmative Action/Equal Opportunity Employer.

MP83-PD-3-13RWC